

PARD



USA
User Manual

Multi-spectral Thermal/Night Vision
TD32/TD62 Series

Scan To Enjoy Privilege



Scan The QR Code To Join Our Membership

- 1 Extend warranty
- 2 Enjoy 1 on 1 expert service
- 3 Get the product experience officer opportunity

CONTENTS

1. Introduction	02
2. Precautions	02
3. Package Contents	03
4. Description & Key Features	04
5. Specifications	05
6. Components & Controls	12
7. Installation	14
8. Operation Instruction	23
8.1 Shortcut Mode	25
8.2 Menu Mode	30
9. Statement	44

INTRODUCTION

Thank you for your continued support and for choosing the PARD TD32/TD62 multi-spectral thermal/night vision device series. Please read this manual carefully before using the device for the first time. Please follow the instructions in this manual to avoid any damage caused by improper use and to ensure that your device operates properly.

After reading, please keep this manual in a safe place for future reference. This manual provides step-by-step instructions on how to use your multi-spectral thermal/night vision device and is intended for your reference only.











PARD reserves the right to amend this manual at any time without prior notice to individual users. For the most up-to-date information, we recommend visiting PARD's official website. PARD reserves the final right of interpretation of this manual.

PRECAUTIONS

- Please remove the insulating tape from the battery before first use. It is recommended to use a fully charged lithium-ion battery with a voltage rating of 3.7V.
- Please turn off the device and remove the battery when it's not in use for more than 10 days and store the device & battery in a dry and safe place.
- Be extra cautious and handle the device with care during use or transportation. It is recommended to use the original packaging during transportation.
- Do not use the device to focus directly on strong sources of light such as the sun or electric welding. The detector may be damaged, and it will void the warranty.
- Avoid lens scratches and damage caused by oil or chemical contamination of the lens. Keep the lens cap on when not in use.
- The device should be placed in a cool, dry, and ventilated environment without strong electromagnetic fields, and the storage environment temperature should not be lower than (-20°C/-4°F) or higher than (50°C/122°F).

- Do not disassemble the device without authorization. If you encounter any problems, please contact our after-sales and report any issues. Failure to do so will render the warranty service null and void.
- **Attention !** Export of all PARD night-vision and thermal imaging devices outside your country requires a license .

PACKAGE CONTENTS

Icon	Contents	Quantity
	Multi-spectral Thermal/Night vision unit	1
	3.7V 21700 Rechargeable lithium-ion battery	1
	30mm Standard mount rings	2
	Type-C cable	1
	Rubber eye cup	1
	Protective case	1
	Allen wrench	3
	IR adjustment screw (IR version only)	1
	Lens cloth	2
	User's manual	1

S	After-sales card	1
---	------------------	---

DESCRIPTION & KEY FEATURES

TD32/TD62 is a multi-spectral thermal/night vision device, pioneered and released by PARD, opening a new chapter in the shooting sports. It creatively combines the characteristics of long-distance thermal imaging detection with the characteristics of highly-detail night vision, the TD32/TD62 can switch between thermal and night vision in only seconds, and features a picture-in-picture (PIP) mode allowing you to see both images simultaneously. The thermal imaging module is equipped with NETD \leq 25mK (0.025 $^{\circ}$ C), 12 μ m high-performance sensor. The night vision module is equipped with high-sensitivity CMOS detector, with the TD32/TD62 also has a 1000m/1200 yd laser range finder (LRF) to accurately measure the distance, the LRF automatically feeds the integrated ballistics calculator making your shots more accurate. In addition, TD32/TD62 provides long eye relief and a 800*800 IPS ultra-high-definition circular screen.

Key features

- 1 Multi-spectral thermal/day&night vision PIP mode
- 2 Effortlessly switch between thermal imaging and night vision displays within second
- 3 Long eye-relief display system
- 4 800*800 IPS circular screen
- 5 Image shift one-shot zeroing
- 6 12 μ m high-sensitivity infrared sensor
- 7 350m direction adjustable fill light
- 8 Infrared Image Enhancement Algorithm (IREA) & Visible Light Enhancement Algorithm (VLEA)
- 9 1000m/1200yd LRF
- 10 Upgraded UI design
- 11 Multifunctional control knob
- 12 WiFi
- 13 IP67 weatherproof rating
- 14 6000J recoil resistance

SPECIFICATIONS

Model	TD32-70	TD62-70
Classification	Multi-spectral Thermal/Night vision	
IR Sensor		
Type	Uncooled Vox IR Sensor	
Resolution(pixel)	384*288	640*512
Pixel Size(μm)	12*12	
NETD	≤25mK(0.025°C)	
Frame Rate(Hz)	50	
Human Detection Distance(m)	1400	1800
Vehicle Detection Distance(m)	2600	3300
Image Engine	PARD IREA	
Objective Lens(mm)	35	45

Optical Magnification(x)	3	2
Digital Zoom(x)	2	
Continuous Digital zoom(x)	3-6	2-4
Focus Range	3m-∞	
Field of View (horizontal)	5.7°	5.6°
Field of View (vertical)	5.7°	5.6°
Field of View (diagonal)	8°	5.6°
Visible Light Sensor		
Type	CMOS Sensor	
Resolution(pixel)	1920*1080	
Pixel Size(μm)	2.9	
Sensitivity(lux)	0.001	
Frame Rate(fps)	60/30	30

Objective lens(mm)	70
Optical Magnification(x)	6.5
Digital Zoom(x)	2
Continuous Digital zoom(x)	6.5-13
Field of View (horizontal)	2.6°
Field of View (vertical)	2.6°
Field of View (diagonal)	3.6°
Image Engine	PARD VLEA
Focus Range	3m-∞
Display	
Type	IPS LCD
Resolution(pixel)	800*800
Reticle Style	6

Reticle Color	4(Red/White/Yellow/Green)
Scene Mode	City/Rain/Forest
Image Mode	WT-HOT/BK-HOT/EDGE/ RD-HOT/IN-HOT/SKY
Eye Relief(mm)	100
Diopter Adjustment(D)	-5~+3
Photo / Video	
Photo Resolution(pixel)	2592*1944
Photo Format	.JPG
Video Resolution(pixel)	Thermal: 1024*768
	Night Vision: 1440*1080
Video Format	.mp4
Storage(GB)	Micro SD card (Max. 128)
Main Function	
LRF Detection Range(m/yd)	1000/1200

PIP	Yes
Gyroscope	Yes
Loop Recording	Yes
Red Dot	Yes
E-compass	Yes
Shutter	Mechanical shutter
Microphone	Yes
Firmware Upgrade	Yes
IR Illuminator	
IR Type	VCSEL
IR Power(W)	5
IR Illuminating Level	3 Levels

IR Distance(m)	350
IR Wavelength(nm)	850/940
Interfaces	
USB Type-C	Yes
HDMI Output	Yes
Connections	
WiFi	Yes
Supported Apps	PardVision
Power Supply	
Battery	Li-ion 21700*1
Output Voltage(V)	3.7
Operating Time(h)	≤6
External Power Supply Type	Type-C

Environmental Characteristic	
Degree of Protection	IP67
Operating Temp(°C/°F)	-20 ~ +50 / -4 ~ +122
Recoil Resistance(J)	6000
Material	
Housing	Aluminum alloy
Objective Lens	All-glass multi-coated lens
Measurement	
Product Dimension (L * W * H, mm)	350*91*95
N.W/pcs(Without Battery, g)	800

COMPONENTS & CONTROLS



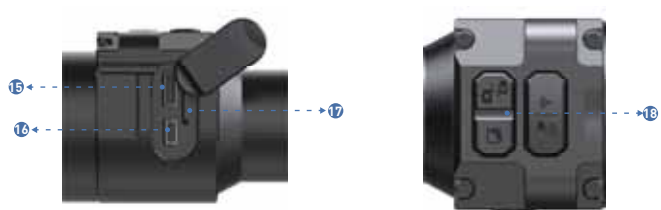

No.	Name	No.	Name
1	Battery cap	10	Thermal lens
2	Control knob	11	Night vision lens cap
3	Key panel	12	Night vision lens focus lever
4	Eyepiece	13	IR light
5	Focus ring	14	Thermal lens cap
6	Power button	15	Type-C charging port
7	Battery compartment	16	HDMI port
8	LRF module	17	TF card slot
9	Thermal lens focus lever	18	Power indicator

INSTALLATION

1. Unboxing

Before using this device, please do the following:

- 1 Open the box and remove the device.
- 2 Check to ensure that the package contents listed above are all included in the box.
- 3 Check the device for any damage to the display, body, lens, buttons, etc.
- 4 Make sure that the objective lens and eyepiece are clean & functioning properly.

Note: If any accessories are missing or damaged, please contact our after-sales service.

2. Battery Installation and Startup

The battery installation steps are as follows:

2.1 Turn the battery cap counterclockwise until it opens and remove the battery.



2.2 Remove the insulating tape.



2.3 Put the positive pole(+) of the battery inwards, and then turn the battery cap clockwise until the battery cap is locked.

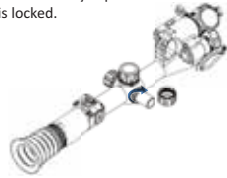

2.4 To turn on the device, press and hold the power button for about 3 seconds. (When the power light illuminates and the PARD Logo appears on the screen, the device is ready for use.)

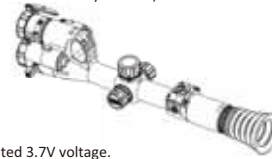

Note:

- 1 Please use a single 21700 rechargeable lithium-ion battery rated 3.7V voltage.
- 2 Do not put battery into fire.
- 3 Do not put device into water when the battery cap is open.
- 4 Do not disassemble the device without authorization.
- 5 Do not pierce the device with sharp objects.
- 6 The battery should be kept out of reach of children, and the positive and negative terminals of the battery should be installed correctly.

3. Mount Installation

To ensure the best user experience, we highly recommend using our original mount included in the product packaging, as shown in Picture 1.

- 1 Take out the multi-spectral device, two scope rings and the Allen wrench out of the box.
- 2 Use the Allen wrench to unscrew the ring tops and loosen the screws on the bottom half of the mount.
- 3 Attach the bottom half of your rings to the rail.
- 4 Tighten the screw on the rear mount to your rail to the desired position.

- 5 Place the scope in the scope rings. The scope should slide with minimal resistance.
- 6 Install the ring tops and tighten down the screws and make sure the scope stays level.

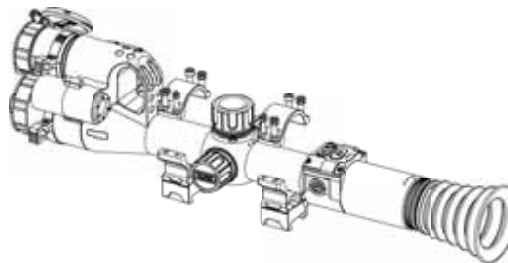

Picture 1

4. Diopter Focusing

Diopter focusing is used to adjust to users with different levels of corrected vision to clearly see the content displayed on the screen, as shown in picture 2.

- 1 After powering on the device, rotate the diopter focusing wheel until you can see the screen clearly.
- 2 Please note that the image may not be clearly visible before objective lens focus is adjusted. Only the wording and symbols on the display screen are clearly visible at this stage.

Note: The image may not be clear if the objective lens is not focused properly.

5. Objective Lens Focusing

- 1 Before you focus the objective lens, ensure that the diopter focusing has been completed.
- 2 Aim at the target you want to see, and turn the focus lever of the objective lens until you can see the target image, as shown in picture 3.

Note: If the screen display is a thermal imaging image, please adjust the thermal imaging objective lens focus lever accordingly, if the screen display is a night vision device image, please adjust the night vision objective lens focus lever accordingly.

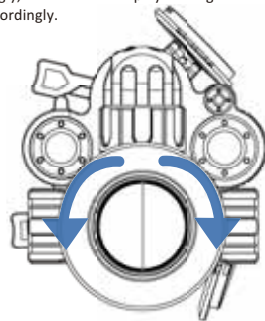

Picture 2

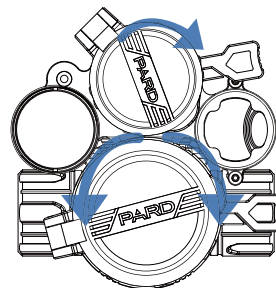

Picture 3

6. Compass Calibration

After the eyepiece is focused, please use the "figure 8 pattern method" to calibrate the electronic compass. Users are required to tilt and move the device in a figure 8 motion until the compass is calibrated, as shown in picture 4.

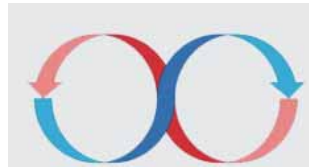

Picture 4

7. Zeroing (Reticle Adjustment)

Reticle Adjustment refers to aligning the reticle with the point of impact at a zeroing distance, so that the position of the aiming point at this specific distance corresponds with the point of impact.

1. Interface Explanation

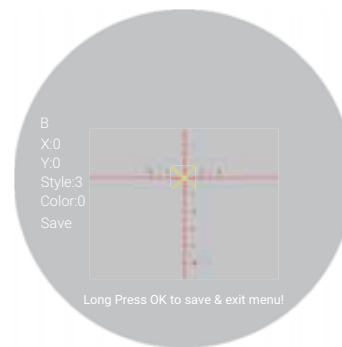

Picture 5

- The first item in the sub-menu represents the saved "zero" setting, there are five profiles A-E.
- "X" represents the X axis of the cross line.
- "Y" represents the Y axis of the cross line.
- Style corresponds to the crosshair type (6 options available).
- Color corresponds to the color of the cross line (red/white/yellow/green), as shown in Picture 5.
- Under the Save option, "Y" means to SAVE, and "N" means DO NOT SAVE.

2. Zeroing Steps

Note: Under the premise of ensuring correct clamping, the dual-light fusion device needs to be reset twice. First, select the thermal imaging screen/night vision screen and follow the steps below to reset to zero. Second, after zeroing the thermal imaging/night vision channel, save the settings and return to the home screen.

Third, rotate the [knob] counterclockwise to switch to the night vision/thermal imaging screen.
Fourth, press the [knob] to enter the Reticle Adjustment option for zeroing again.

Note: Keep the device stable and ensure the zeroing point remains consistent during this operation.

- 1 **Set the target** : Set the target at zeroing distance and ensure that the device can obtain a good image.
- 2 **Enter to reticle adjustment (Zeroing page)** : In the home screen mode, press [Key 1] to enter the shortcut menu mode and rotate the [knob] counterclockwise to move the cursor to the reticle adjustment setting option. Press [Key 1] to enter the sub-menu interface, as shown in Picture 6.



Picture 6

3 **Profile setting** : After entering the zeroing page, rotate "RTZ" items from A-E to create a new zeroing profile or edit an existing one as shown in Picture 7.

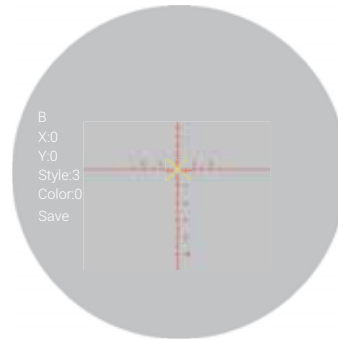

Picture 7

4 **Point of impact**: take the first shot at the center of the target (A), ensuring that a clear point of impact (B) becomes visible on the screen after the shot has been taken as shown in Picture 8.

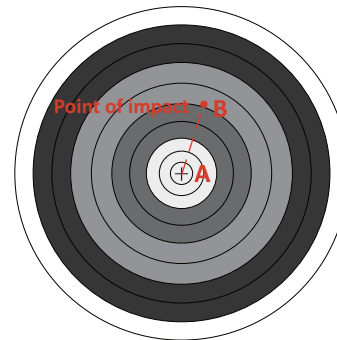

Picture 8

- 5 **Adjust zero value** : Rotate the [knob] to freeze the screen and adjust the values of "X" and "Y" until the center point of the reticle (A) is moved to the point of impact (B) on the display screen.
- 6 **Save and exit** : Rotate [knob] clockwise to set the "Save" item to "Y". After the setting is completed, press and hold [Key 1] to save and exit. The actual point of impact is moved to the center point of the reticle. (The reticle is always at the center of the screen, which can maximize the use of the entire observation field.)

Note : In the thermal imaging zero screen, the X-axis direction can achieve horizontal alignment with the impact point by moving the background image, the cross line is always horizontally centered, and the Y-axis direction can achieve vertical coincidence with the landing point by adjusting the position of the cross line. Night vision reset Zero screen, X, Y axis directions are all achieved by moving the background image to achieve horizontal alignment with the impact point, and the crosshairs are always centered.

Operation Instruction



Picture 9



Picture 10

1. Shortcut Mode

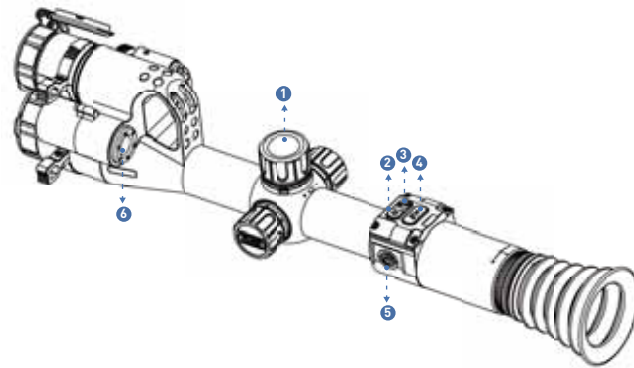

Picture 11

Knob (Key1)	Rotate counterclockwise	Rotate clockwise	Double press
	Down/-/Switch spectral channels	Up/+/Zoom	-
	Single press	Press and hold	Double press
	Quick menu/OK	Full menu	PIP

	Single press	Press and hold	Double press
(Key2)	Color palettes/IR level	Scene modes	-
(Key3)	Take a photo	Record video	Files
(Key4/6)	LRF/Trajectory calculation/Back	WiFi	Shutter correction

Explanation

Key 1

1. Single press:

- ① **Home screen mode:** press [Key 1] to enter the shortcut menu.
- ② **Menu mode:** press [Key 1] means confirm.

2. Press and hold:

Home screen mode: press and hold [Key 1] to enter the full menu.

3. Double press :

- ① **Home screen mode:** double press [Key 1] to turn on/off the picture-in-picture function.

4. Rotate counterclockwise :

- ① **Home screen mode:** rotate the knob counterclockwise to switch the spectral channel (the thermal imaging display and the night vision display are switched between each other).
- ② **Menu mode:** rotate the [knob] counterclockwise to scroll down between menu options. In the parameter setting interface under the sub menu, rotate the [knob] counterclockwise to decrease the values.

5. Rotate clockwise :

- ① **Home screen mode:** rotate the [knob] clockwise to switch the magnification.
- ② **Menu mode:** [knob] clockwise in the menu option interface to switch menu options upward. In the parameter setting interface under the sub menu, rotate the [knob] clockwise to increase the values.

Key 2

1. Single press:

In the thermal imaging home screen mode: click [Key 2] to switch the image mode WT-HOT/BK-HOT/EDGE/RD-HOT/IN-HOT/SKY.

In the night vision home screen mode: and when the infrared fill light is turned on, click [Key 2] to switch the brightness of the infrared fill light from off--1 Level--2 Level--3 Level--OFF .

2. Press and hold :

In the thermal imaging home screen mode: press and hold [Key 2] to switch between City/Forest/Rain scene mode.

In the night vision home screen mode: press and hold [Key 2] to switch between night vision color mode and B&W mode.

Key 3

1. Single press:

Home screen mode: press [Key 3] to take a photo.

2. Press and hold :

Home screen mode: press [Key 3] to record a video. Press and hold [Key 3] again to save the video and exit.

3. Double press :

Home screen mode: double press [Key 3] to enable the playback function. After entering this interface, the video and picture files in the memory card will be displayed.

- ① Rotate the [knob] to switch between files.
- ② Press [Key 1] to play/pause the saved videos.
- ③ When playing videos, rotate the [knob] to fast forward or rewind 2x/4x/8x times.
- ④ Press [Key 4] to access the following settings;
Rotate the [knob] to switch among these settings, press [Key1] to enter the selected setting.

- | | | |
|------------------|--------------------|---------------|
| 1)Delete: | 2)File Protection: | 3)Slide Show: |
| • Delete Current | • Lock Current | • 2 seconds |
| • Delete All | • Unlock Current | • 5 seconds |
| | • Lock All | • 8 seconds |
| | • Unlock All | |

Note: Navigate through these sub-options by rotating the [knob], and access them by pressing [Key1]. To exit the current sub-option screen, simple press [Key 4].

- ⑤ To return to the main interface, press and hold [Key 4].

Key 4/6

1. Single press:

- ① **Home screen mode:**
 - Press [Key 4/6] to start the range detection function (For LRF version, the distance will be measured and displayed automatically. For the non-LRF version, the distance is not measured automatically and will display "[0]m or [0]yds". You need to manually input the target distance value by rotating the [knob]).
 - Press [Key 4/6] a second time to turn on the trajectory indicator (when the trajectory calculator is turned off, the range indicator is turned off).

- Press [Key 4/6] a third time to turn off the trajectory indicator (when the ballistic calculator is turned on).
- ② **Menu mode:** press [Key 4/6] to return to the previous page.

2. Press and hold :

Home screen mode: press and hold [Key 4/6] to turn on/off the WiFi function.

3. Double press :

In the thermal imaging home screen mode: double press [Key 4/6] to start the shutter correction function (Under the auto shutter mode).

2. Menu Mode

Home screen mode: press [Key 1] to enter the shortcut menu mode. Press and hold [Key 1] to enter the full menu setting mode to set various function options (the shortcut key function is invalid at this time).

1. Image Setting

Users can adjust the image contrast, brightness, detail, sharpness and mode under this setting, as shown in Picture 12.

- Rotate the [knob] counterclockwise to move the cursor to the image setting option, press [Key 1] to enter the sub-menu.
- Press [Key 1] to switch between Contrast / Brightness / Detail / Sharpness / Mode options and rotate the [knob] to adjust the option value.
- Press and hold [Key 1] to exit. Upon the next startup, the device will maintain the saved image settings.

Image default settings: contrast value is 105, brightness value is 60, detail is 5, sharpness is 2 and the mode value is 3.

2. Display Brightness

Users can adjust the display brightness of the screen to adapt to different surroundings, as shown in Picture 13.

- Rotate the [Key 1] counterclockwise to move the cursor to the display brightness option, press [Key 1] to enter the sub-menu.
- Rotate the [Key 1] to move the cursor to select "Level 0" / "Level 1" / "Level 2" / "Level 3" / "Level 4" / "Level 5" / "Level 6" options.
- Press [Key 1] to save and return to the previous page.

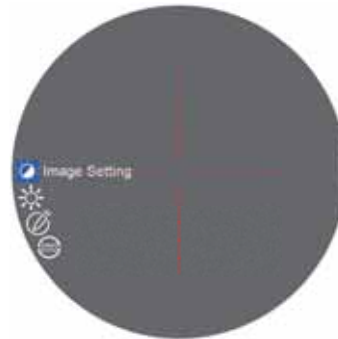

Picture 12



Picture 13

3. Range Unit Selection

Users can switch between "Meter" or "Yard" and the range unit can be updated instantly to meet the user's preference.

- ① Rotate the [knob] counterclockwise to move the cursor range unit selection option, and press [Key 1] to enter the sub-menu.
- ② Rotate the [knob] to choose between "Meter" or "Yard", then press [Key 1] to save and return to the previous page.

4. Reticle Adjustment

Reticle Adjustment refers to aligning the reticle with the point of impact at a zeroing distance, so that the position of the aiming point at this specific distance corresponds with the point of impact.

- ① Rotate the [knob] counterclockwise to move the cursor to the reticle adjustment setting option. Press [Key 1] to enter the sub-menu interface.
- ② Press [Key 1] to switch sub-menu options. Rotate the [knob] to adjust the value of the corresponding item (please see the detailed instructions from above zeroing steps).
- ③ After selecting your preferred settings, there are two saving methods:
 1. Set "Yes" under Save option, press the [Knob] to save and exit.
 2. No matter whether "Yes" or "No" under Save option, press and hold the [Knob] also means to save and exit.

5. Shutter Mode

The heat generated by the detector itself will affect the imaging effect of the device. Through the shutter mode, the device will detect any slight heat changes which exceed a set range, deviation will cause the shutter to automatically close and the device will perform self-calibration. This will improve edge to edge clarity of the image.

Auto shutter: The system detects the temperature value of the sensor simultaneously. When the change value exceeds the system setting, the shutter will close and pause the image for about 1 second to perform self-calibration operation.

Shutterless: The system detects the temperature value of the detector chip in real-time and uses the built-in algorithm to calibrate the image in real time.

- ① Rotate the [knob] counterclockwise to move the cursor to the shutter mode setting option, and press [Key 1] to enter the sub-menu.
- ② Rotate the [knob] to move the cursor to select "Auto shutter" and "Shutterless" option.
- ③ Press [Key 1] to save and return to the previous page.

6. Gyroscope

This function measures the orientation of the device so that the yaw and pitch angles of the device can be displayed and calibrated.

- ① Rotate the [knob] counterclockwise to move the cursor to the gyroscope setting option, and press [Key 1] to enter the sub-menu.
- ② Rotate the [knob] to select "Display" or "Calibration", and then press [Key 1] to enter.
- ③ "Display" indicates whether (or not) to display the yaw and pitch angle of the device on the home screen. Rotate the [knob] to select "Off" or "On", and press [Key 1] to save and return to the menu.
- ④ "Calibration" means to enter the calibration state. After selecting, please place the device on a horizontal plane surface, and press [Key 1] to perform automatic calibration. After calibration, the device will automatically return to the home screen.

7. Scene

There are three built-in scene modes, "City", "Forest" and "Rain". Users can choose any of the available scenes to achieve the best image display effect based on the environment.

- ① Rotate the [knob] counterclockwise to move the cursor to the scene option, press [Key 1] to enter the sub-menu.
- ② Rotate the [knob] to move the cursor to select "City", "Forest" or "Rain" mode. Press [Key1] to save and return to the previous page.

8. Picture in Picture

- ① Rotate the [knob] counterclockwise to move the cursor to the PIP setting option, and press [Key 1] to enter the sub-menu.
- ② Rotate the [knob] to move the cursor to select "Off" or "On".
- ③ Press [Key 1] to save and return to the previous page.

Note: For multi-spectral devices, the picture-in-picture displays the thermal imaging and night vision images respectively. In the picture-in-picture mode, turn [Key 1] counterclockwise to quickly switch between thermal imaging and night vision images; and because of the multi-spectral, the imaging shows that the centers of the reticle in the two images do not point to the same position of the target.

9. Hot Track

The device can detect and display the highest temperature point on the screen, and automatically track this target heat source.

- ① Rotate the [knob] counterclockwise to move the cursor to the hot track setting option, and press [Key 1] to enter the sub-menu.
- ② Rotate the [knob] to move the cursor to select "Off" or "On". Press [Key 1] to save and return to the previous page.

Note: This function can only be displayed in thermal image mode.

10. Self-activated Recording

When the device detects recoil, the whole shooting process will be recorded in 20 second intervals. The incremental 20-second video footage will be saved on the TF card.

- ① Rotate the [knob] counterclockwise to move the cursor to the self-activated recording setting, and press [Key 1] to enter the sub-menu.
- ② Rotate the [knob] to select "OFF", "ON" and "Impact Sensitivity" options.
- ③ After selecting "Off" or "On", press [Key 1] to save and return to the previous page.
- ④ After selecting "Impact Sensitivity", press [Key 1] to enter the sub-option menu of sensitivity level. Rotate the [knob] to select "Off", "Low", "Medium" or "High" mode. Press [Key 1] to save and return to the previous page.

11. Default Magnification

After turning on the device, users can use this function to select the default magnification of night vision channel.

- ① Rotate the [knob] counterclockwise to move the cursor to the default magnification setting option, and press [Key 1] to enter the sub-menu.
- ② Rotate the [knob] to select the default magnification you want, and then press [Key 1] to save and return to the previous page.

12. Default Color

There are 4 built-in color modes of night vision channel, "Color"/"Black & White"/"Yellow" and "Green". Users can choose their preferred color settings.

- ① Rotate the [knob] counterclockwise to move the cursor to default color setting option, and press [Key 1] to enter the sub-menu.
- ② Rotate the [knob] to select "Color"/ "Black & White"/ "Yellow" and "Green", and then press [Key 1] to save and return to the previous page.

13. Brightness of IR

In the night vision working mode, users can choose the level of brightness of IR settings.

- ① Rotate the [knob] counterclockwise to move the cursor to the brightness or IR setting option, and press [Key 1] to enter the sub-menu.
- ② Rotate the [knob] to select "Off", "1", "2", "3" and then press [Key 1] to save and return to the previous page.

14. Auto Power Off

After selecting your preferred time duration, the device will sense the last point of operation before beginning the shutdown. Auto power off will start after the device has been idle then it automatically triggers the auto power off command.

- ① Rotate the [knob] counterclockwise to move the cursor to select the auto power off setting, and press [Key 1] to enter the sub-menu.
- ② Rotate the [knob] to select "Off", "1 Min", "10 Min" or "30 Min" duration options. After selection, press [Key 1] to confirm and save, and return to the previous page.

15. Auto Recording

After auto recording is turned on, device will start recording and continue to record after the next startup.

- ① Rotate the [knob] counterclockwise to move the cursor to the auto recording setting option and press [Key 1] to enter the sub-menu.
- ② Rotate the [knob] to select "Off" or "On" options, press [Key 1] to save and return to the previous page.

16. Loop Recording

Users can customize the segment recording duration. This can be set up under loop recording. When the capacity of the memory card is full, the new recording will automatically overwrite the previous saved files. When you select "Off", the recording will stop when the memory card is full, and the oldest video file will not be overwritten.

- ① Rotate the [knob] counterclockwise to move the cursor to the loop recording setting option, and press [Key 1] to enter the sub-menu.
- ② Rotate the [knob] to move the cursor to select preferred loop time duration "Off", "3 Min", "5 Min" or "10 Min". Press [Key 1] to save and return to the previous page.

17. Date Stamp

Users can set whether to display the time stamp in the lower right corner of photos and videos taken.

- ① Rotate the [knob] counterclockwise to move the cursor to the date stamp setting option, and press [Key 1] to enter the sub-menu.
- ② Rotate the [knob] to move the cursor to select "Off" or "On" options. After selection, press [Key 1] to save and return to the previous page.

18. Record Audio

User can set whether to record audio synchronously in the video.

- ① Rotate the [knob] counterclockwise to move the cursor to the recording audio setting option, press [Key 1] to enter the sub-menu.
- ② Rotate the [knob] to move the cursor to select "Off" or "On" option, after selection, press [Key 1] to save and return to the previous page.

19. WiFi

Through the WiFi connection, you can use your phone, PC or tablet as an external viewfinder enabling users to synchronously see the photos and videos on a larger screen.

- ① Rotate the [knob] counterclockwise to move the cursor to the WiFi setting option, and press [Key 1] to enter the sub-menu.
- ② Rotate the [knob] to move the cursor to select "On" or "Off" option. Select "Off" and return to the previous page. Select "On" to enable WiFi and return to the home screen.

Steps to connect to your mobile device:

- ① Download "PardVision" from the Apple App Store or the Google Play Store.
- ② Turn on the WiFi on your device and on your mobile device.
- ③ Search the WiFi on your mobile device (the device WiFi network is a string of characters starting with PARD, which is a unique string of numbers). Please enter the password: 12345678 to connect.
- ④ Enter the application to operate and use.

Note: After the WiFi is turned on, you cannot access the menu. Press and hold [Key 4] to disable the WiFi and then enter the menu interface.

20. Exposure

In the night vision working mode, users can choose their preferred exposure settings.

- ① Rotate the [knob] counterclockwise to move the cursor to the exposure setting and press [Key 1] to enter the sub-menu.
- ② Rotate the [knob] to select your preferred option. Press [Key 1] to confirm your selection.

21. Language

Users can choose their preferred language.

- ① Rotate the [knob] counterclockwise to move the cursor to the language setting option, press [OK] to enter the sub-menu.
- ② Rotate the [knob] to move the cursor to select the desired language. Press [Key 1] to switch the system language and return to the previous page.

22. Date/Time

Users can set the system date and time of the device.

- ① Rotate the [knob] counterclockwise to move the cursor to the date/time setting option, press [Key 1] to enter the sub-menu.
- ② Rotate the [knob] to adjust the setting date and time value, press [Key 1] to switch options, press [Key 4] to save and return to the previous page.

23. ICON Display

To access the menu, press and hold [Key1], then rotate the [knob] counterclockwise to locate the ICON Display option. Press [Key 1] to enter the submenu. Use the [knob] to select options such as On, 30SEC, 1Min, 3Min, 5Min or 10Min, and press [Key 1] to confirm. Selecting On ensures constant visibility of icons on the home screen, while choosing 30SEC makes the icons disappear after 30 seconds, and so on. Press any key icon to resume display.

24. Format

If users want to reformat the TF Card, it will delete all the data on the TF card permanently. Data cannot be recovered after reformatting. **Please operate with caution!**

- ① Rotate the [knob] counterclockwise to move the cursor to the format setting option, and press [Key 1] to enter the sub-menu.
- ② Rotate the [knob] to move the cursor to select "Cancel" or "OK" option. After selection, press [Key 1] to confirm the relevant operation and return to the previous page.

25. Blind Pixel Compensation

The blind pixel compensation algorithm enables effective compensation for blind spots that no longer respond to light and reduces image distortion, as shown in Picture 14.

- ① Press and hold the [Key 1] to access the menu, turn the [knob] counterclockwise to locate the Blind Pixel Compensation option. Press the [Key 1] to enter, and a prompt will appear: "Please put on lens cap, long press the menu key to execute, short press the ranging key to exit."
- ② Long press the [Key 1] to active the blind spot compensation function. A prompt will display: "Blind spot compensation, please wait".
- ③ Once the compensation is completed, a prompt will appear: "Blind spot compensation back up". Select Yes to backup, or No to exit and return to the previous menu.
- ④ Short press the [Key 4] to exit the Blind Pixel Compensation option.

③ Short press the [Key 4] to exit the Blind Pixel Compensation option.



Picture 14

26. Default Settings

If users decide to reset the device, it will restore the device to the factory default settings and all the user data and personalized settings will be deleted. **Please operate with caution!**

- ① Rotate the [knob] counterclockwise to move the cursor to restore default setting option, press [Key 1] to enter the sub-menu.
- ② Rotate the [knob] to move the cursor to select "Cancel" or "OK" option. After selection, press [Key 1] to confirm the relevant operation and return to the previous page.

27. Firmware Upgrade

System firmware can be updated to maintain an optimized current version.

- ① Rotate the [knob] counterclockwise to move the cursor to the firmware upgrade option, and press [Key 1] to enter the sub-menu. You will see an important reminder: Upgrading firmware may cause damage to the equipment, **please operate with caution!**
- ② Press and hold [Key 1] to confirm and press [Key 4] to exit and return to the previous page.

Note: Please ensure that the TF card is inserted before performing this operation. When performing this operation. Please load the device with a fully charged battery and type-C power supply. Powering off the device during the firmware update process may cause damage to the device components. Please operate with caution.

28. Version

This function displays the device's version.

- ① Knob the [knob] counterclockwise to move the cursor to the version option, press [Key 1] to enter the sub-menu to view.
- ② Press [Key 1] again to exit and return to the previous page.

Statement

FCC WARNING

This device complies with part 15 of the FCC Rules. Operation is subject to the following two conditions:

- (1) This device may not cause harmful interference.
- (2) This device must accept any interference received, including interference that may cause undesired operation.

Note: This equipment has been tested and found to comply with the limits for a Class B digital device, pursuant to part 15 of the FCC Rules. These limits are designed to provide reasonable protection against harmful interference in a residential installation. This equipment generates, uses and can radiate radio frequency energy and, if not installed and used in accordance with the instructions, may cause harmful interference to radio communications. However, there is no guarantee that interference will not occur in a particular installation. If this equipment does cause harmful interference to radio or television reception, which can be determined by turning the equipment off and on, the user is encouraged to try to correct the interference by one or more of the following measures:

- Reorient or relocate the receiving antenna.
- Increase the separation between the equipment and receiver.
- Connect the equipment into an outlet on a circuit different from that to which the receiver is connected.
- Consult the dealer or an experienced radio/TV technician for help.

Note: The Grantee is not responsible for any changes or modifications not expressly approved by the party responsible for compliance. such modifications could void the user's authority to operate the equipment. The device has been evaluated to meet general RF exposure requirement. This equipment complies with FCC's RF radiation exposure limits set forth for an uncontrolled environment. This device and its antenna(s) must not be co-located or conjunction with any other antenna or transmitter.

Follow Us



Facebook



Instagram



YouTube



LinkedIn



Website

www.pard.com

Business Cooperation

sales.support@optimaxtechnologyllc.com

Service Center

aftersales@optimaxtechnologyllc.com

PARD USA

 Optimax Technology LLC

 +1 (800) 986 4370

 3500 Lakeside Court Suite 200, Reno, NV 89509, US

CE  FC RoHS